

Kelvion



Kelvion Service

**YOUR RELIABLE  
SERVICE  
PARTNER**

Kelvion



# EXPERTS IN HEAT EXCHANGE – SINCE 1920

Welcome to Kelvion! Where Heat Exchange is our Business. We are one of the leading global manufacturers of heat exchangers and have been providing solutions for almost every industrial application imaginable since the 1920s, specializing in customized solutions suitable for extreme environmental conditions - as of 2015 under the name of Kelvion.

With one of the most extensive selections of heat exchangers in the world, we are a well-known partner in many industries, including transportation, energy, oil and gas, the heavy industry, chemical and marine as well as sugar, food and beverage and the HVAC and refrigeration technology sector. Our products include Compact Fin Heat Exchangers, Plate Heat Exchangers, Single Tube Heat Exchangers, Transformer Cooling Systems, Cooling Towers and Shell & Tube Heat Exchangers.

Our many years of experience and in-depth expertise have made us specialists in this field. Our heat exchangers are designed specifically to meet the needs of the respective machine or equipment system, ensuring outstanding energy efficiency and reliability in any market segment. This gives our customers a cutting-edge over their competitors while also reducing operating costs over the long term.

As your heat exchange partner, we understand that outstanding and reliable after-sales services are critical for you, our customer, and we work alongside with you in close partnership supporting you throughout the full life cycle of your plant and equipment to ensure lasting business success.

Kelvion – Experts in Heat Exchange.

## KELVION – A TRIBUTE TO LORD KELVIN (1824 - 1907)



Lord Kelvin formulated the laws of thermodynamics and absolute units of temperature are stated in kelvin, in his honor.

## OUR LOGO – INSPIRED FROM THE SCHEMATIC FOR HEAT EXCHANGER

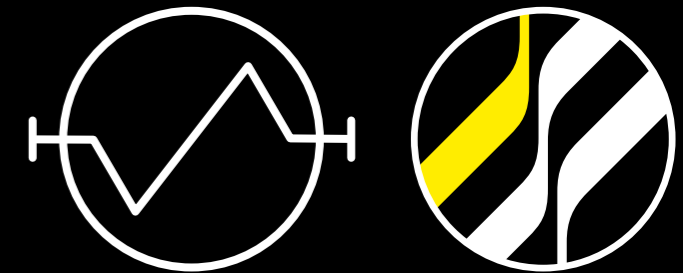

## 67 BRANCHES AND SALES PARTNERS WORLDWIDE

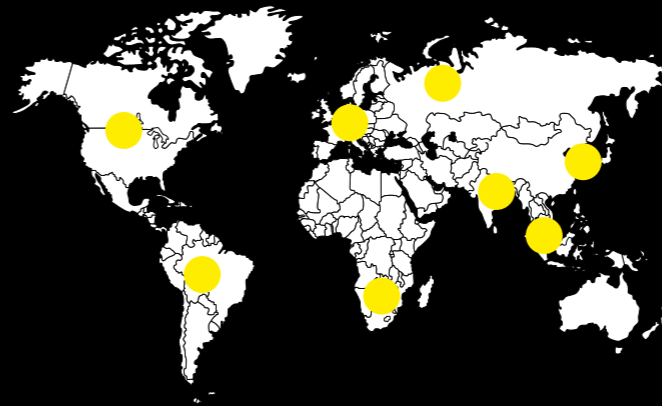

## 4,500 EMPLOYEES WORLDWIDE

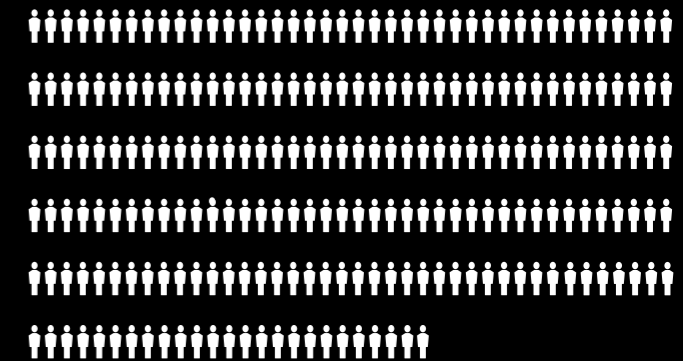

## YOUR MARKETS ARE OUR MARKETS

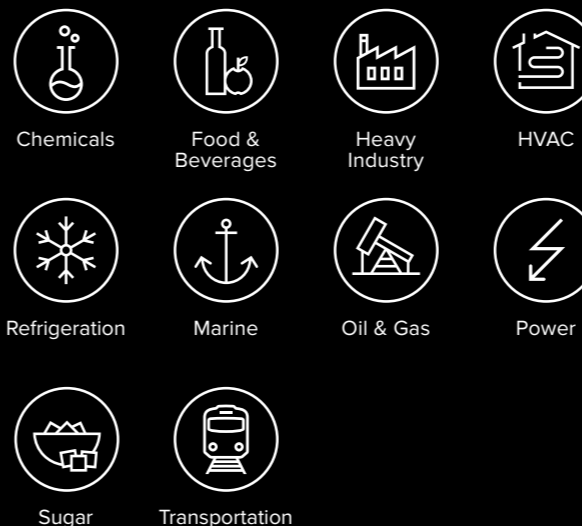

## KELVION HAS A LONG HISTORY





## Kelvion Service

# OUR SERVICE IN THREE WORDS: PEACE OF MIND

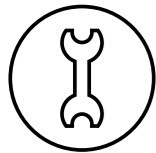

Developing and supplying products and solutions is one side of our business – comprehensive after-sales support and service is the other. Supporting you after you have made a purchase is paramount.

This principle has made us a highly reliable service specialist. Our tightly-woven network of locations worldwide means we can offer our customers maximum availability wherever they are and at any time. Our service work provides us with a continual stream of new knowledge and experiences that culminate in valuable improvements and enables us to fully optimize our range of services.

These services include precise installation work, in-house or on-site trouble shooting, visual inspection and performance audit as part of proactive maintenance, repair and cleaning, tube replacement, provision of spare parts, and the chemical cleaning of product components in our own service workshops. Whatever we do for you, our services are oriented to specific values:

### Quality and safety

With individual customer consulting and precise work, we reach the heights of service quality.

### Innovation

Innovative service solutions help us meet your requirements.

### Efficiency

Our parts and services increase profitability: We optimize operational procedures and maximize the availability of our systems for you.

### Expertise

You benefit from the knowledge and experience of decades of service activity.

### Trust

Our service employees act in a reliable, responsible, and transparent manner to earn your trust.

## The Top 5 Challenges for our customers

# WE CAN HELP YOU ALONG THE COMPLETE PRODUCT LIFE CYCLE

### 1 Avoid unscheduled downtime

Unscheduled downtime is enemy number one for many industrial companies as it leads to significant financial losses. Unplanned work stoppages cost global industries billions of dollars in lost revenue. The solution is to prevent them from happening. Kelvion provides you with full maintenance support for your equipment, including preventive measures. By monitoring your heat exchanger's performance and operation on a regular basis, preventive measures can be taken to minimize the chance of unscheduled downtime.

What 1 minute of downtime costs:

**\$22,000/min**



**\$8,851/min**

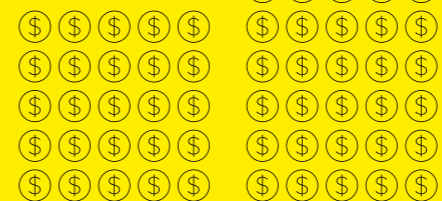

**\$65/min**



**Airlines**  
Delays



**Data Centers**  
Unplanned outages



**Auto Industry**  
Unexpected stoppages

Source: <http://uk.businessinsider.com>

### 3 Increase process efficiency

Many businesses have successfully embraced Six Sigma, Kaizen and other lean methods for increasing their process efficiency. However, if the heat exchangers in your process do not function properly, the performance of the process will be influenced negatively. Over time, heat exchangers can lose efficiency due to various reasons, for example erosion or incorrect pressure heights. Kelvion is always available to advise you and carry out the necessary work to keep your processes efficient.

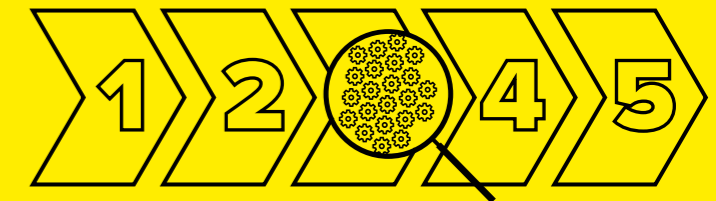

### 4 Manage the variety of brands

Heat exchangers are an essential part of many industrial processes and can be found everywhere. In our almost 100 years' experience in supplying heat exchanger technology, we have rarely seen customers with one product brand. The challenge is to manage different brands of heat exchanger that you have to ensure that they all work effectively and to a high standard. Our expert technicians have the know-how to service all heat exchanger brands.

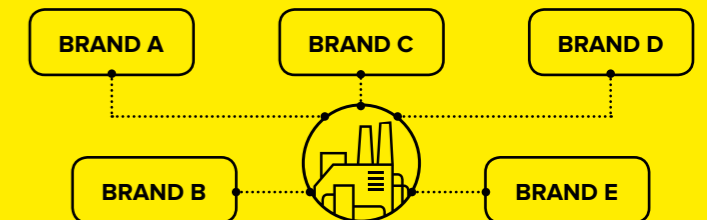

### 2 Prevent CAPEX investments

In today's tough economic environment organizations are increasingly reluctant to commit to capital investment. Growing business uncertainty and the volatility of markets means that many businesses are unwilling to spend capital, which they may not have or may not bring a return on their investment. Also they may need to protect their cash flow. A cost-efficient way of keeping operations running smoothly for longer is through upgrading equipment and replacing parts, as well as regular maintenance.



### 5 Having the right maintenance skills

You have your own maintenance organization taking care of maintaining the critical components in your equipment or process. As technology advances and innovative solutions rise faster than mushrooms during fall season, it is always a challenge to keep the competences and skills of your people up to date. Kelvion offers training programs designed to increase competency and efficiency of your maintenance personnel.

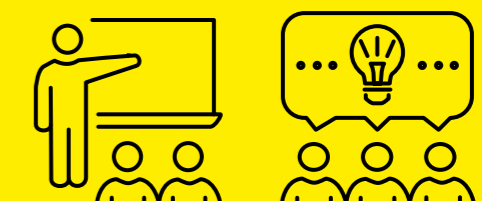

# OUR SERVICE OFFER TO YOU

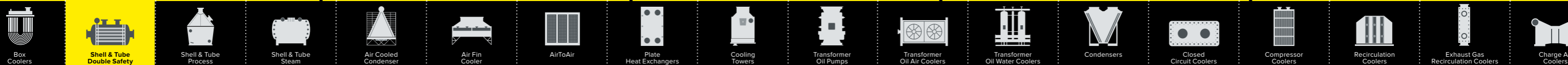
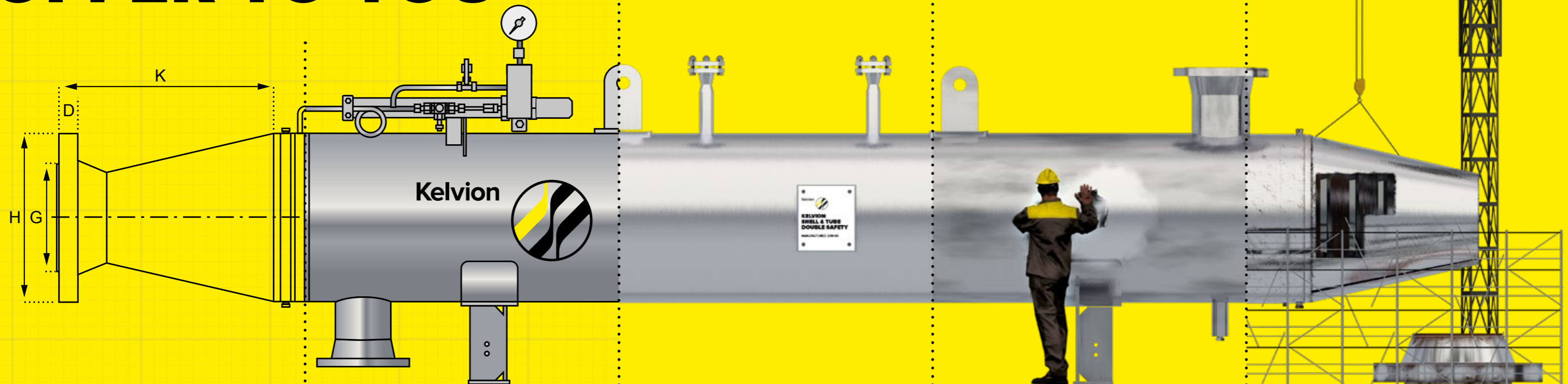

## START-UP SERVICES

We ensure that our products are delivered safely and are fully validated to have a trouble-free start-up and to give a robust and reliable performance during operation. We can supervise the installation, ensuring our high standards are followed, but also consult you about the best ways to keep maximum reliability and availability over the lifetime of your heat exchanger.



## REPAIRS AND OVERHAULS

We understand that unscheduled downtime can be disastrous. That is why our trained engineers are ready to respond quickly in an emergency. We will review and repair components while keeping any disruption to a minimum. Any overhaul work is carried out in our service centers and conforms to the highest quality standards.



## TESTING AND MONITORING

Having an understanding of the condition of the equipment allows you to secure reliable production, improve safety and energy efficiency and increase equipment lifetime. It can also help you to prevent breakdowns and prepare for the future.

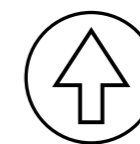

## UPGRADES AND REPLACEMENTS

We replace components to keep our heat exchangers running smoothly and to prevent downtime. Where parts have become obsolete, we will suggest an upgrade.



## SPARE PARTS AND SPARE PARTS SOLUTIONS

Even the best equipment shows signs of wear over time. We use only the highest quality spare parts, designed to match the excellence of the originals. This ensures that the optimum interaction between components is maintained. By safeguarding the original design we offer maximum security of your investment.



## INSPECTIONS AND MAINTENANCE

Through regular inspections and maintenance, we help you to reduce costs, extend the lifetime of all your heat exchanger products, achieve a reliable performance, and to keep in line with the latest laws and regulations. This will enable you to plan your budget more accurately.



## CONSULTING AND TRAINING

Taking into account the special features of your process and finding the right solutions is more important to us than closing a deal quickly. We will work closely with you to develop the exact solution that is best tailored to your needs. Besides this Kelvion offers training programs designed to increase competency and efficiency of your maintenance personnel.

**ALL BRAND SERVICE**

Besides being experts in our own products and our former brand, we also have the expertise to service other brands.

**PERFORMANCE AGREEMENTS**

Performance Agreements are individually tailored service solutions that can include any of the services in our extensive service portfolio. Based on your specific needs, they maximize your return on investment, ensure continual performance excellence and make budgeting simpler.



# BOOSTING PERFORMANCE



## The customer's business

A global leader in animal nutrition in the south of France produces feed for billions of livestock at farms worldwide. The production process produces large amounts of water vapor that is used to generate electricity for the entire plant via turbines. The company uses an Air Cooled Condenser (ACC) to cool down the water to cool the turbine.

## The need for a solution

During a routine cleaning of the finned tube bundles of the ACC, Kelvion discovered that the airflow wasn't functioning properly. We carried out a full audit which showed that the airflow of the two ACC fans was below 50% of the original specification, resulting in a huge underperformance of the complete installation. With the summer season – and rising temperatures - on the way, the customer faced a major risk of downtime for a critical component.

## The implementation

Kelvion calculated that selecting another fan profile, changing the motors and the gearbox, and redesigning the ejector skid (which was based on old technology), would raise the performance to the required level. The design was done by our specialist consultant who also ensured that the existing walkway could support the new equipment with minor changes. In addition, we provided a fogging system and ladder-mounted cleaning systems to make future maintenance easier.

## The solution in action

The installation was split into three phases to make the most efficient use of the planned shutdown period. First, the removal and replacement of the old ejector skid, the installation of the two ladder-mounted cleaning systems, and positioning the pumping skid that supplies the water for fogging and cleaning systems. The second phase involved taking down the ACC fans, replacing the old motors and gearbox, and installing the new fans. Phase three was the commissioning of the pumping skid, fogging system and cleaning systems. To complete the job we cleaned the ACC tube bundles with the help of the customer's maintenance personnel who wanted to learn how to do this themselves in future.

## The result

The new ACC design resulted in a performance gain of 215% and allowed the turbine to produce 6-7 megawatts of electricity steadily. During the hot dry summer months the fogging systems allow for an even higher performance increase.

# KELVION SERVICE AT A GLANCE

The Kelvion Service starts from our first contact with you and continues after your order has been delivered, with us as your reliable service partner. With many years of experience in the field of service management, along with our service centers worldwide, we can guarantee the satisfaction of our customers.

## 30 SERVICE LOCATIONS WORLDWIDE

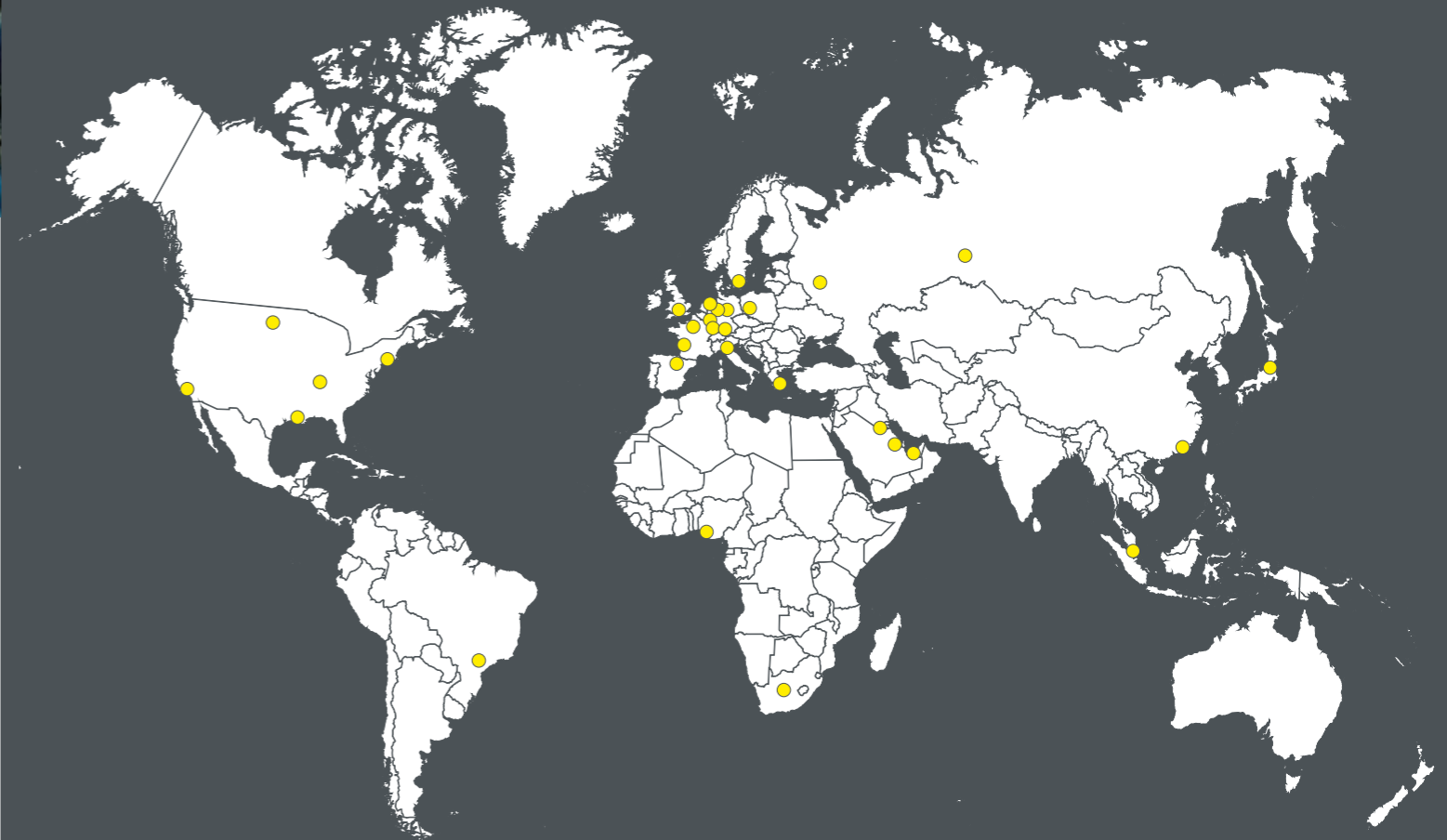

[service@kelvion.com](mailto:service@kelvion.com)



[www.kelvion.com/service](http://www.kelvion.com/service)

# FAIRNESS FIRST: FOR CUSTOMERS, EMPLOYEES, COMPETITORS, AND THE ENVIRONMENT

Companies such as Kelvion that are internationally active are obliged to conform to internationally accepted conventions: of social, political, and legal nature. Our corporate code of conduct describes the principles and procedures behind our corporate actions. This code applies to all our employees worldwide. We ensure compliance with the regulations in a working environment that is characterized by integrity, respect, fairness, and responsibility.

## **We respect and observe the law.**

The basis for all action at Kelvion is the observation of all applicable laws and other regulations. We supplement these rules with especially designed, particularly strict internal guidelines and training with regard to certain aspects of the law.

## **We act internationally.**

Kelvion strictly observes as binding the statutory regulations that apply to our products and services involved in international commerce. We observe all applicable bans on exports and imports and observe all official authorization procedures.

## **We wholly reject corruption.**

Kelvion rejects any type of commercial corruption, both domestically and on foreign markets. In order to underline this fact, we have drawn up our own anti-corruption guidelines that enforce rules of proper conduct to which we adhere at all times. These rules apply both in our dealings with officials and with the bodies and employees of other companies.

## **We support fair competition.**

In a spirit of fair competition, we work hard, orient this work to our customers' needs and ensure the quality of our products and services. We observe all applicable domestic, supranational, and foreign anti-trust laws as well as any laws pertaining to unfair competition. We also expect this level of fairness from our competitors.

## **We ensure socially acceptable working conditions.**

We are committed to the principles of social responsibility towards our employees and society. Kelvion offers its employees fair working conditions worldwide. We reject any form of discrimination, with respect to gender, sexual orientation, origin, skin color, or any other personal characteristics. We see ourselves as a socially responsible employer that treats its employees with respect.

## **We protect the environment.**

From development, to manufacturing, and to the sale of our products, we protect the environment throughout each of these phases. This principle applies not only to the energy we employ, but also to the protection of our natural environment at every workplace worldwide.

## **We ensure product safety.**

For our customers, we develop innovative, high-quality products and processes – and product safety enjoys top priority.

[www.kelvion.com](http://www.kelvion.com)